

Received October 14, 2020

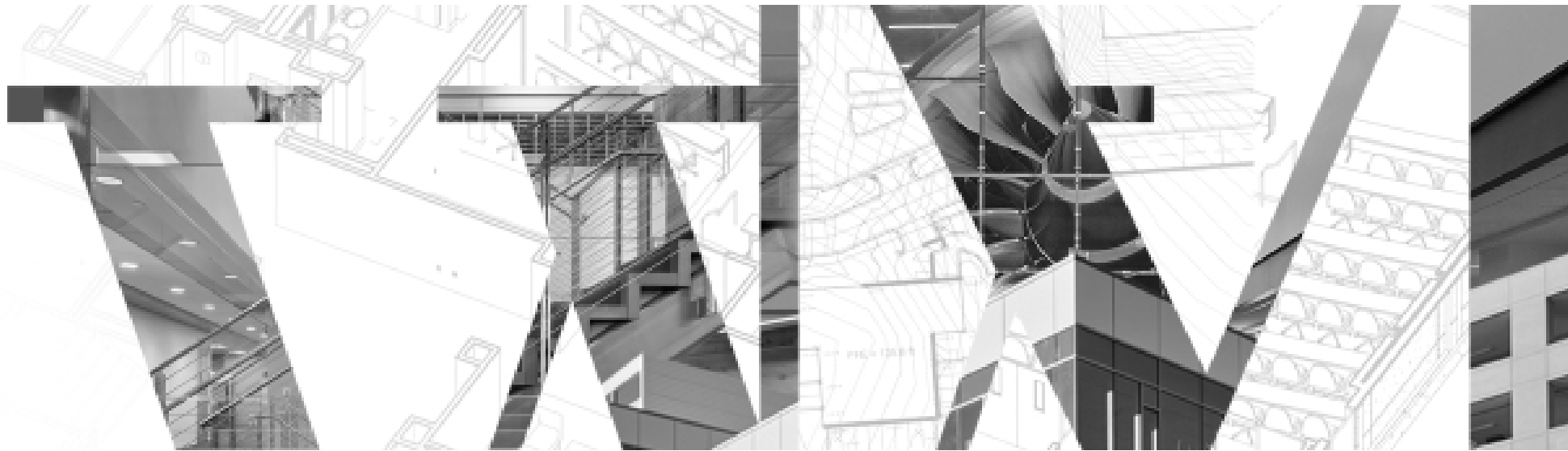

**PUBLIC STORAGE  
PLEASANTON**

3716 STANLEY BLVD,  
PLEASANTON, CALIFORNIA

CONCEPTUAL DESIGN  
SNR17-0075-00  
09.29.2020

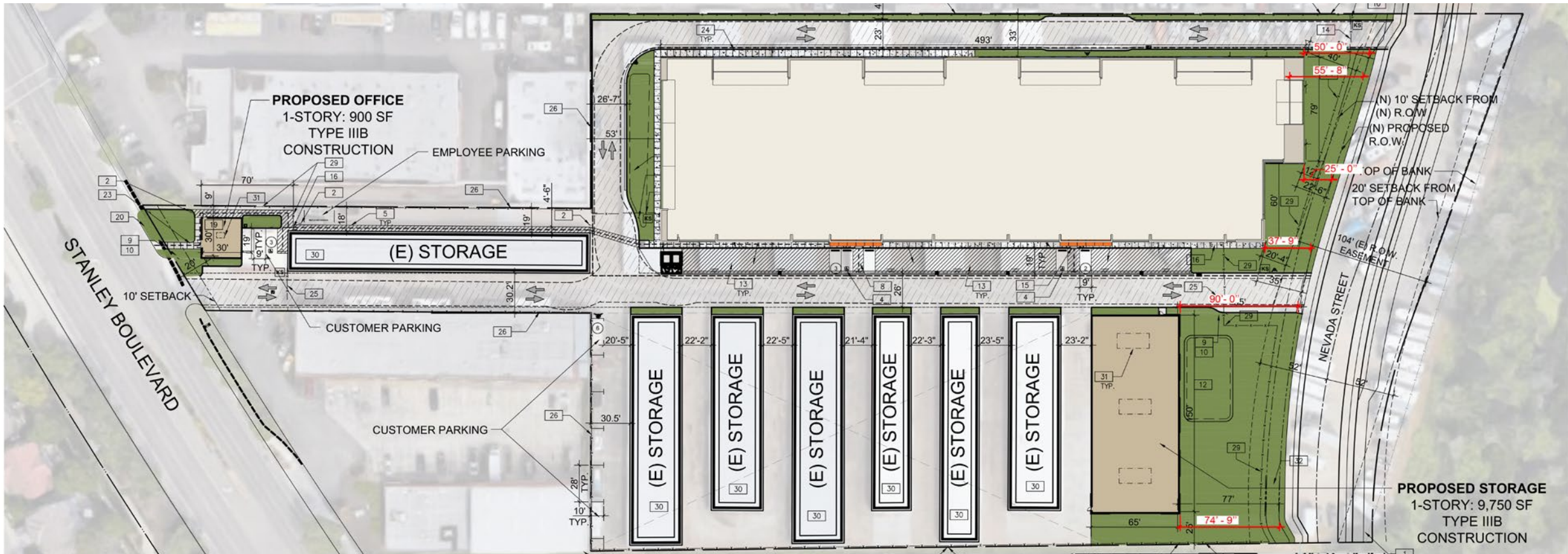

ORIGINAL SCHEME - SITE PLAN

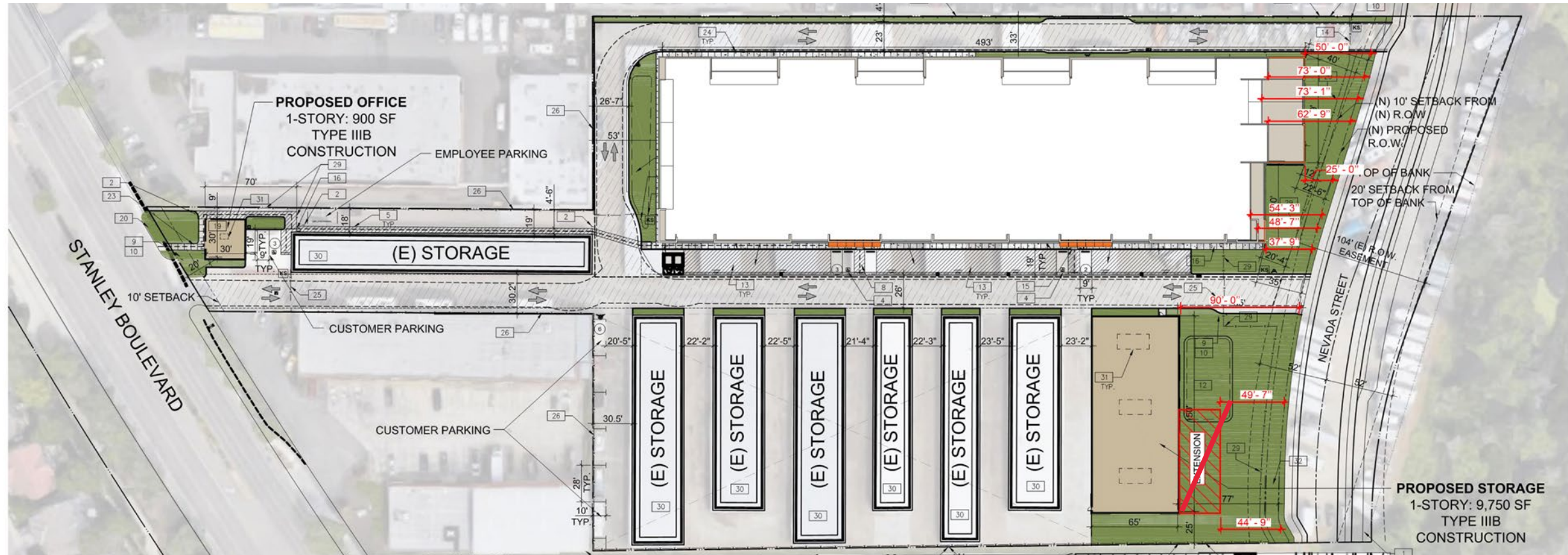

PROPOSED SCHEME - SITE PLAN



This conceptual design is based upon a preliminary review of entitlement requirements and on unverified and possibly incomplete site and/or building information, and is intended merely to assist in exploring how the project might be developed. Signage shown is for illustrative purposes only and does not necessarily reflect municipal code compliance. All colors shown are for representative purposes only. Refer to material samples for actual color verification.

SITE PLAN

PUBLIC STORAGE PLEASANTON  
PLEASANTON, CA - SNR17-0075-00

WARE MALCOMB

09.29.2020

PAGE  
2

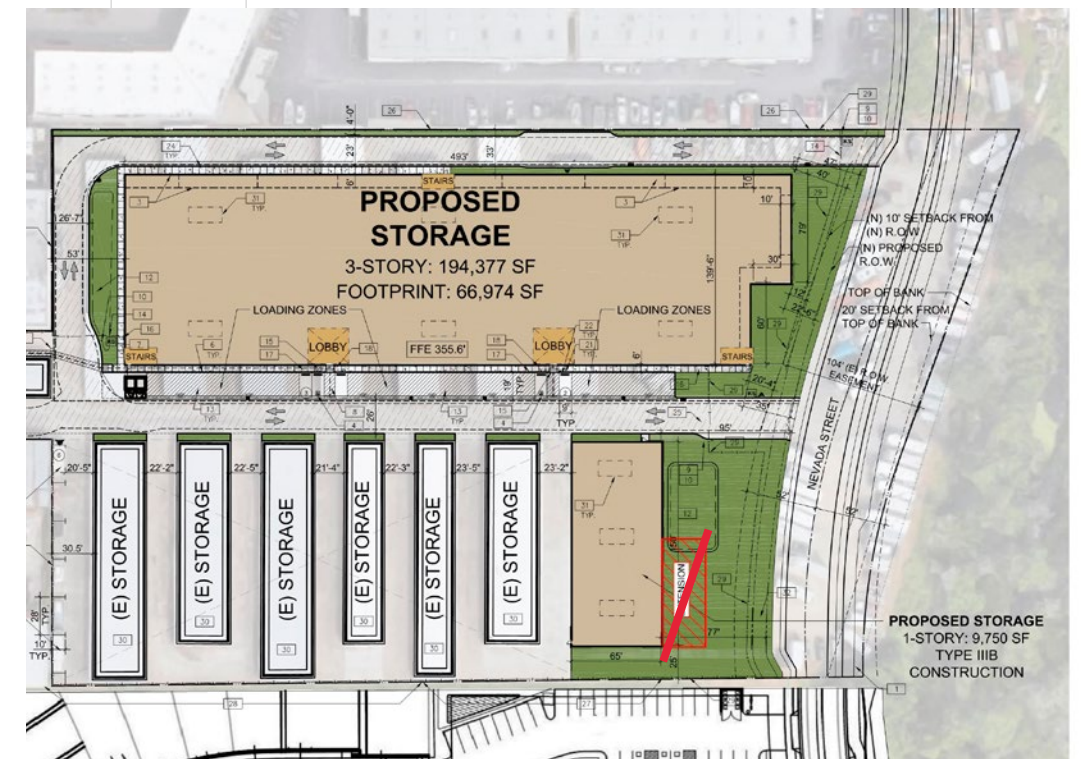

This conceptual design is based upon a preliminary review of entitlement requirements and on unverified and possibly incomplete site and/or building information, and is intended merely to assist in exploring how the project might be developed. Signage shown is for illustrative purposes only and does not necessarily reflect municipal code compliance. All colors shown are for representative purposes only. Refer to material samples for actual color verification.

SINGLE STORY BUILDING FLOOR PLAN  
**PUBLIC STORAGE PLEASANTON**  
 PLEASANTON, CA - SNR17-0075-00

**WARE MALCOMB** 09.29.2020

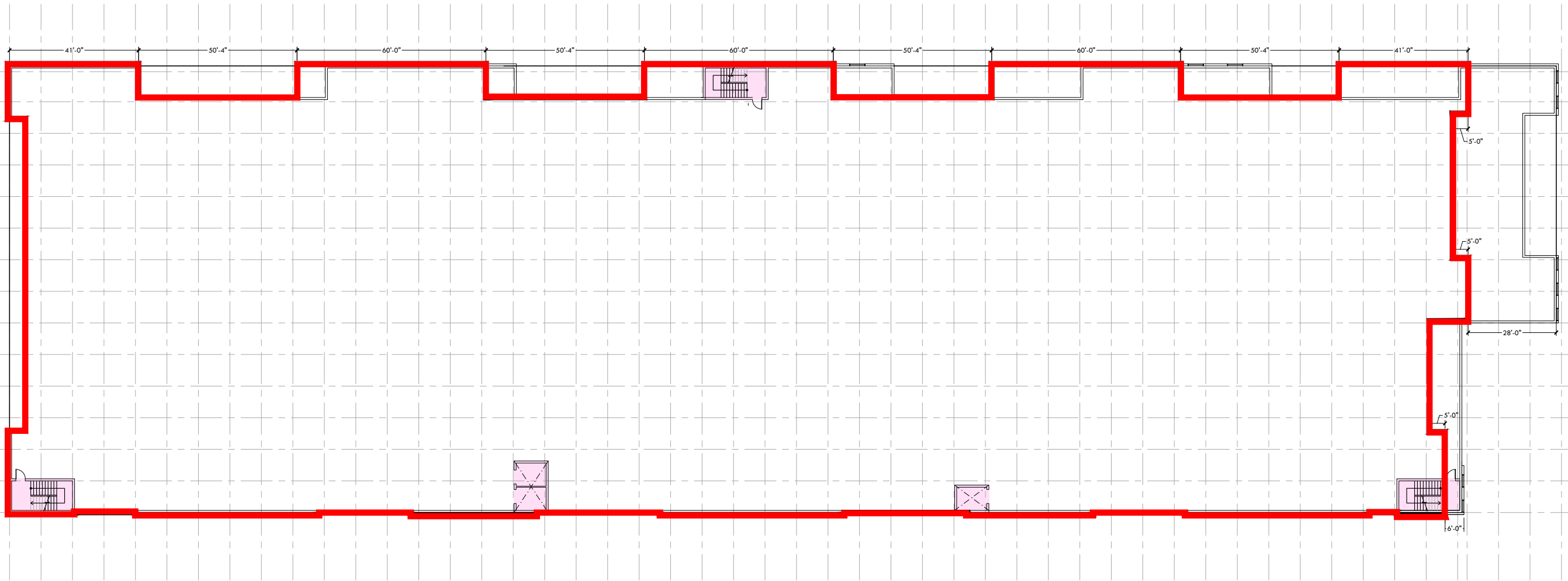

— PROPOSED FLOOR PLAN



This conceptual design is based upon a preliminary review of entitlement requirements and on unverified and possibly incomplete site and/or building information, and is intended merely to assist in exploring how the project might be developed. Signage shown is for illustrative purposes only and does not necessarily reflect municipal code compliance. All colors shown are for representative purposes only. Refer to material samples for actual color verification.

PROPOSED FLOOR PLAN  
**PUBLIC STORAGE PLEASANTON**  
 PLEASANTON, CA - SNR17-0075-00

**WARE MALCOMB** 09.29.2020



This conceptual design is based upon a preliminary review of entitlement requirements and on unverified and possibly incomplete site and/or building information, and is intended merely to assist in exploring how the project might be developed. Signage shown is for illustrative purposes only and does not necessarily reflect municipal code compliance. All colors shown are for representative purposes only. Refer to material samples for actual color verification.

EYE LEVEL VIEW FROM SOUTH EAST

**PUBLIC STORAGE PLEASANTON**  
PLEASANTON, CA - SNR17-0075-00

**WARE MALCOMB**

09.29.2020

PAGE  
5



ORIGINAL SCHEME



PROPOSED SCHEME



This conceptual design is based upon a preliminary review of entitlement requirements and on unverified and possibly incomplete site and/or building information, and is intended merely to assist in exploring how the project might be developed. Signage shown is for illustrative purposes only and does not necessarily reflect municipal code compliance. All colors shown are for representative purposes only. Refer to material samples for actual color verification.

EYE LEVEL VIEW FROM SOUTH EAST

PUBLIC STORAGE PLEASANTON  
 PLEASANTON, CA - SNR17-0075-00

WARE MALCOMB

09.29.2020

PAGE  
 6



This conceptual design is based upon a preliminary review of entitlement requirements and on unverified and possibly incomplete site and/or building information, and is intended merely to assist in exploring how the project might be developed. Signage shown is for illustrative purposes only and does not necessarily reflect municipal code compliance. All colors shown are for representative purposes only. Refer to material samples for actual color verification.

EYE LEVEL VIEW FROM SOUTH WEST

PUBLIC STORAGE PLEASANTON  
PLEASANTON, CA - SNR17-0075-00

WARE MALCOMB

09.29.2020

PAGE  
7



ORIGINAL SCHEME



PROPOSED SCHEME



This conceptual design is based upon a preliminary review of entitlement requirements and on unverified and possibly incomplete site and/or building information, and is intended merely to assist in exploring how the project might be developed. Signage shown is for illustrative purposes only and does not necessarily reflect municipal code compliance. All colors shown are for representative purposes only. Refer to material samples for actual color verification.

EYE LEVEL VIEW FROM SOUTH WEST

PUBLIC STORAGE PLEASANTON  
 PLEASANTON, CA - SNR17-0075-00

WARE MALCOMB

09.29.2020

PAGE  
 8





This conceptual design is based upon a preliminary review of entitlement requirements and on unverified and possibly incomplete site and/or building information, and is intended merely to assist in exploring how the project might be developed. Signage shown is for illustrative purposes only and does not necessarily reflect municipal code compliance. All colors shown are for representative purposes only. Refer to material samples for actual color verification.

EYE LEVEL VIEW FROM SOUTH EAST

PUBLIC STORAGE PLEASANTON  
PLEASANTON, CA - SNR17-0075-00

WARE MALCOMB

09.29.2020

PAGE  
9



ORIGINAL SCHEME



PROPOSED SCHEME



This conceptual design is based upon a preliminary review of entitlement requirements and on unverified and possibly incomplete site and/or building information, and is intended merely to assist in exploring how the project might be developed. Signage shown is for illustrative purposes only and does not necessarily reflect municipal code compliance. All colors shown are for representative purposes only. Refer to material samples for actual color verification.

EYE LEVEL VIEW FROM SOUTH EAST

PUBLIC STORAGE PLEASANTON  
 PLEASANTON, CA - SNR17-0075-00

WARE MALCOMB

09.29.2020

PAGE  
 10

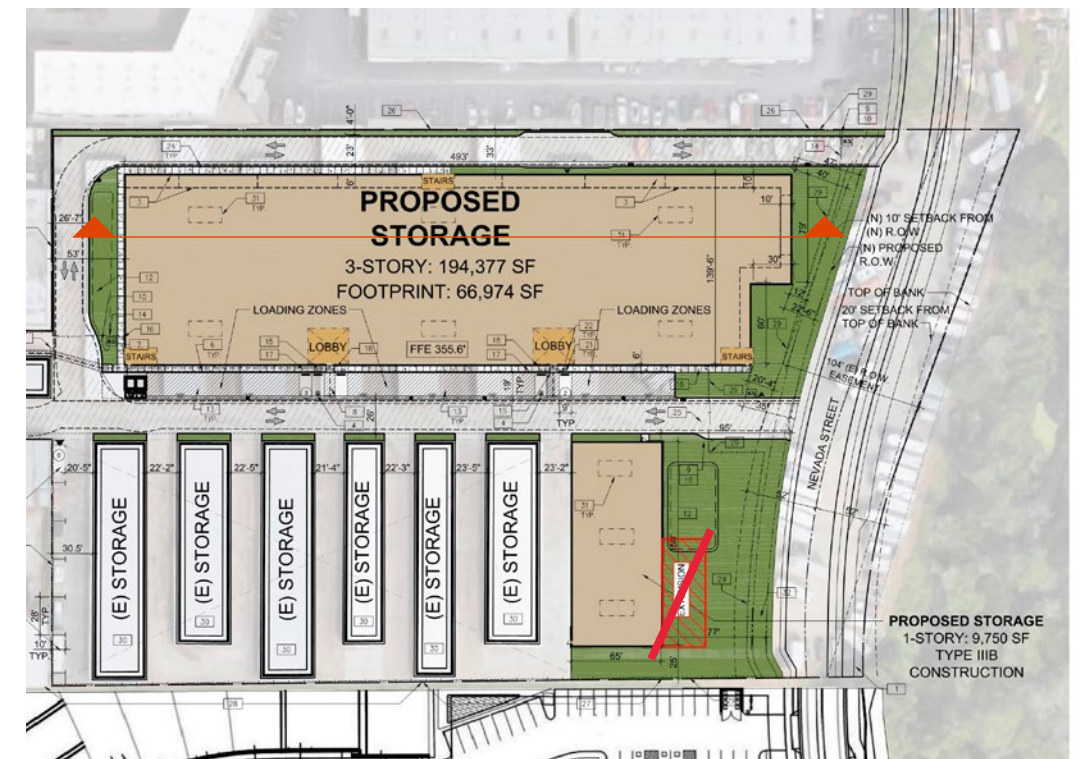
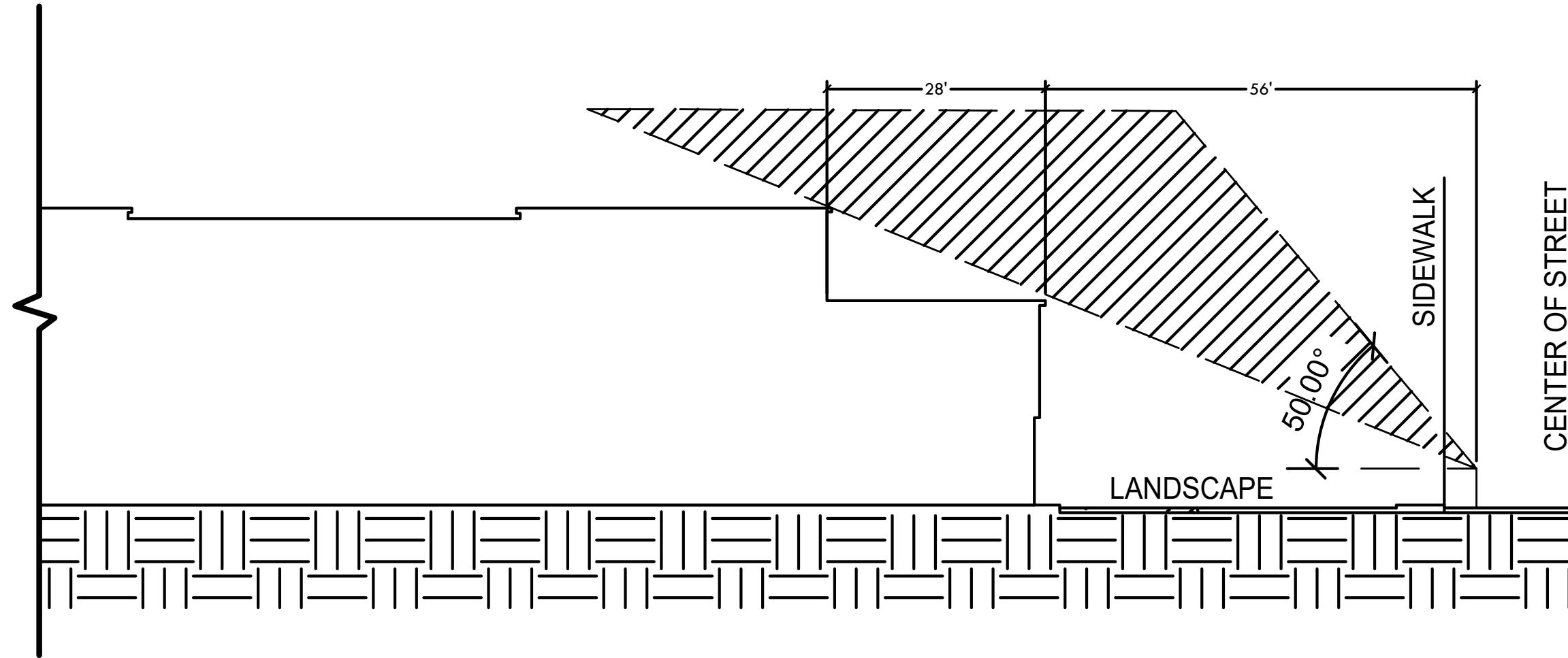

This conceptual design is based upon a preliminary review of entitlement requirements and on unverified and possibly incomplete site and/or building information, and is intended merely to assist in exploring how the project might be developed. Signage shown is for illustrative purposes only and does not necessarily reflect municipal code compliance. All colors shown are for representative purposes only. Refer to material samples for actual color verification.

LINE OF SIGHT SECTION

**PUBLIC STORAGE PLEASANTON**  
PLEASANTON, CA - SNR17-0075-00

**WARE MALCOMB**

09.29.2020

PAGE  
11